

All inclusive stand packages - with one signature to the fair

BVV Trade Fairs Brno
 Výstaviště 405/1
 603 00 Brno
 Tel.: +420 601 252 613
 E-mail: lpokorna@bvv.cz
www.bvv.cz/expozice



**DIGITAL
FACTORY**



October 7 - 10, 2025, Brno - Czech Republic, www.bvv.cz/msv

**Special discount
for registration
till March 31, 2025**

The standard stands can also be ordered in a ROW arrangement, see the online application form at www.bvv.cz/msv

**R1
9 sqm**

**Standard stand - TYPE R1, 3 x 3 m, total price up to 31. 3. 2025 CZK 87 510,- excl. VAT
after 31. 3. 2025 CZK 92 190,- excl. VAT**

The price includes: 9 m2 exhibition area, registration fee, technical fee, stand construction incl. furnishings (see the list), carpet flooring, an inscription of up to 30 characters on fascia, power supply up to 3,6 kW incl. testing, daily cleaning, the company name and address in the fair catalogue and in the electronic information system, 2x Assembly/Dismantling Pass, 2x Exhibitor's Pass.



Stand furnishings:

- 1x 70 cm round table
- 2x chair Bystřice
- 1x information desk
- 1x coat hanger
- 1x wastebasket
- 3x spotlights
- 1x 220 V socket
- 1x graphic surface 136 x 67 cm
excl. graphics
- colour walls and fascia for an extra charge

**R2
9 sqm**

**Standard stand - TYPE R2, 3 x 3 m, total price up to 31. 3. 2025 CZK 89 770,- excl. VAT
after 31. 3. 2025 CZK 94 450,- excl. VAT**

The price includes: 9 m2 exhibition area, registration fee, technical fee, stand construction incl. furnishings (see the list), carpet flooring, an inscription of up to 30 characters on fascia, power supply up to 3,6 kW incl. testing, daily cleaning, the company name and address in the fair catalogue and in the electronic information system, 2x Assembly/Dismantling Pass, 2x Exhibitor's Pass.



Stand furnishings:

- 1x 70 cm round table
- 2x chair Bystřice
- 1x information desk
- 1x coat hanger
- 1x system rack
- 1x wastebasket
- 3x spotlights
- 1x 220 V socket
- 2x graphic surface 95 x 67 cm
excl. graphics
- colour walls and fascia for an extra charge

**R3
9 sqm**

**Standard stand - TYPE R3, 3 x 3 m, total price up to 31. 3. 2025 CZK 99 950,- excl. V AT
after 31. 3. 2025 CZK 104 630,- excl. VAT**

The price includes: 9 m2 exhibition area, registration fee, technical fee, stand construction incl. furnishings (see the list), carpet flooring, power supply up to 3,6 kW incl. testing, daily cleaning, the company name and address in the fair catalogue and in the electronic information system, 2x Assembly/Dismantling Pass, 3x Exhibitor's Pass.

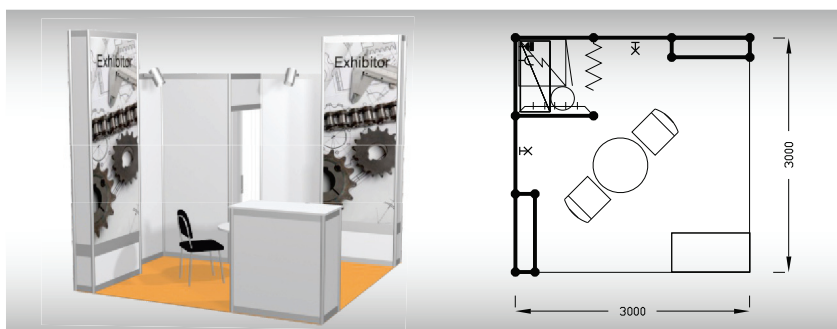

Stand furnishings:

- 1x 70 cm round table
- 2x chair Bystřice
- 1x information desk
- 1x coat hanger
- 1x refrigerator, 1x system rack
- 1x wastebasket
- 2x spotlights
- 1x 220 V socket
- 1x socket for refrigerator
- 2x graphic wall 95 x 234 cm
excl. graphics
- colour walls for an extra charge

Common conditions for all types and sizes of stands:

- The stand will be ready at 10.00 a.m. one day before the fair begins
- Note! - stand dismantling will begin the following day after the fair has ended
- Structural changes for all types of packages are not possible
- Should the exhibitor attach their own posters /banners/ stickers to the wall panels inconsiderately resulting in panel damage, they will be charged an extra fee CZK 880,- / 1 piece
- Rejection or exchange of basic furnishings will not be compensated by any price reduction
- Changes in type and proportion of exhibition area for all types of package stands are not possible
- Stand cleaning is performed every morning before the fair begins

All inclusive stand packages - with one signature to the fair

BVV Trade Fairs Brno
 Výstaviště 405/1
 603 00 Brno
 Tel.: +420 601 252 613
 E-mail: lpokorna@bvv.cz
 www.bvv.cz/expozice



October 7 - 10, 2025, Brno - Czech Republic, www.bvv.cz/msv

Special discount for registration till March 31, 2025

The standard stands can also be ordered in a ROW arrangement, see the online application form at www.bvv.cz/msv

R4
12 sqm

Standard stand - TYPE R4, 4 x 3 m, total price up to 31. 3. 2025 CZK 109 980,- excl. VAT after 31. 3. 2025 CZK 116 230,- excl. VAT

The price includes: 12 m2 exhibition area, registration fee, technical fee, stand construction incl. furnishings (see the list), carpet flooring, an inscription of up to 30 characters on fascia, power supply up to 3,6 kW incl. testing, daily cleaning, the company name and address in the fair catalogue and in the electronic information system, 2x Assembly/Dismantling Pass, 2x Exhibitor's Pass.

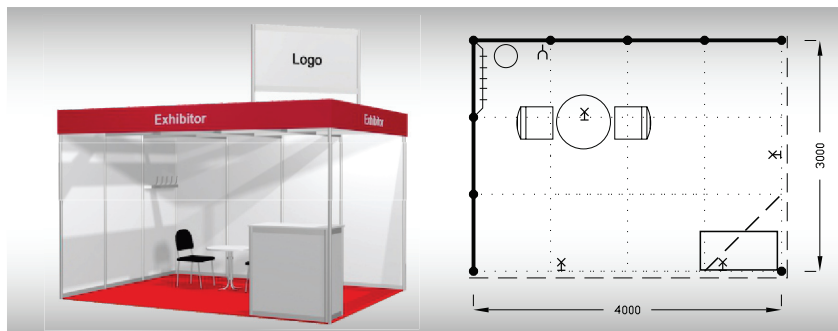

Stand furnishings:

- 1x 70 cm round table
- 2x chair Bystřice
- 1x information desk
- 1x coat hanger
- 1x wastebasket
- 4x spotlights
- 1x 220 V socket
- 1x graphic surface 136 x 67 cm excl. graphics
- colour walls and fascia for an extra charge

R5
12 sqm

Standard stand - TYPE R5, 4 x 3 m, total price up to 31. 3. 2025 CZK 112 410,- excl. VAT after 31. 3. 2025 CZK 118 650,- excl. VAT

The price includes: 12 m2 exhibition area, registration fee, technical fee, stand construction incl. furnishings (see the list), carpet flooring, an inscription of up to 30 characters on fascia, power supply up to 3,6 kW incl. testing, daily cleaning, the company name and address in the fair catalogue and in the electronic information system, 2x Assembly/Dismantling Pass, 2x Exhibitor's Pass.

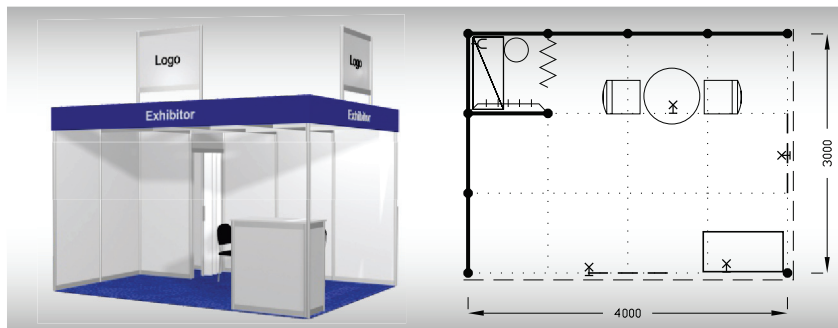

Stand furnishings:

- 1x 70 cm round table
- 2x chair Bystřice
- 1x information desk
- 1x coat hanger
- 1x system rack
- 1x wastebasket
- 4x spotlights
- 1x 220 V socket
- 2x graphic surface 95 x 67 cm excl. graphics
- colour walls and fascia for an extra charge

R6
12 sqm

Standard stand - TYPE R6, 4 x 3 m, total price up to 31. 3. 2025 CZK 121 990,- excl. VAT after 31. 3. 2025 CZK 128 230,- excl. VAT

The price includes: 12 m2 exhibition area, registration fee, technical fee, stand construction incl. furnishings (see the list), carpet flooring, power supply up to 3,6 kW incl. testing, daily cleaning, the company name and address in the fair catalogue and in the electronic information system, 2x Assembly/Dismantling Pass, 3x Exhibitor's Pass.

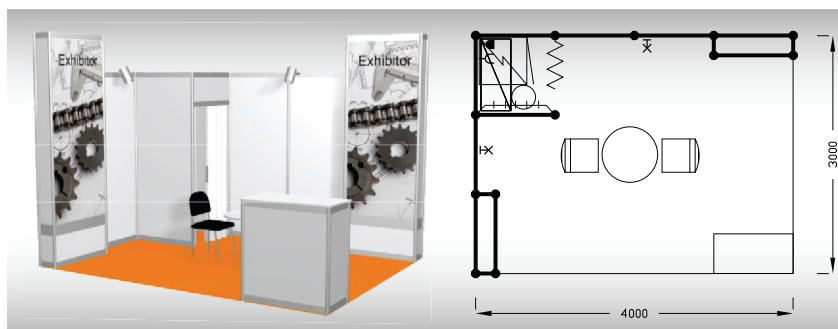

Stand furnishings:

- 1x 70 cm round table
- 2x chair Bystřice
- 1x information desk
- 1x coat hanger
- 1x refrigerator, 1x system rack
- 1x wastebasket
- 2x spotlights
- 1x 220 V socket
- 1x socket for refrigerator
- 2x graphic wall 95 x 234 cm excl. graphics
- colour walls for an extra charge

Common conditions for all types and sizes of stands:

- The stand will be ready at 10.00 a.m. one day before the fair begins
- Note! - stand dismantling will begin the following day after the fair has ended
- Structural changes for all types of packages are not possible
- Should the exhibitor attach their own posters /banners/ stickers to the wall panels inconsiderately resulting in panel damage, they will be charged an extra fee CZK 880,- / 1 piece
- Rejection or exchange of basic furnishings will not be compensated by any price reduction
- Changes in type and proportion of exhibition area for all types of package stands are not possible
- Stand cleaning is performed every morning before the fair begins

All inclusive stand packages - with one signature to the fair

BVV Trade Fairs Brno
 Výstaviště 405/1
 603 00 Brno
 Tel.: +420 601 252 613
 E-mail: lpokorna@bvv.cz
www.bvv.cz/expozice



October 7 - 10, 2025, Brno - Czech Republic, www.bvv.cz/msv

Special discount for registration till March 31, 2025

The standard stands can also be ordered in a ROW arrangement, see the online application form at www.bvv.cz/msv

R7
15 sqm

Standard stand - TYPE R7, 5 x 3 m, total price up to 31. 3. 2025 CZK 135 160,- excl. VAT after 31. 3. 2025 CZK 142 960,- excl. VAT

The price includes: 15 m2 exhibition area, registration fee, technical fee, stand construction incl. furnishings (see the list), carpet flooring, an inscription of up to 15 characters on fascia, power supply up to 3,6 kW incl. testing, daily cleaning, the company name and address in the fair catalogue and in the electronic information system, 2x Assembly/Dismantling Pass, 2x Exhibitor's Pass.

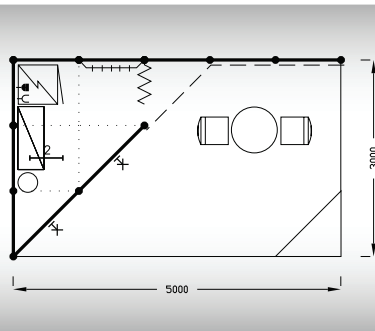
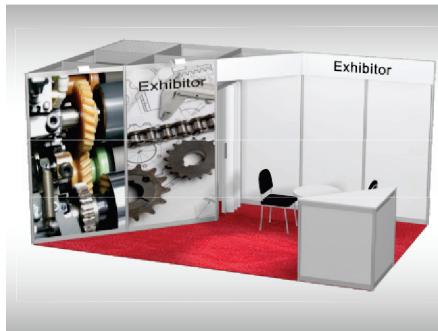

Stand furnishings:

- 1x 70 cm round table
- 2x chair Bystřice
- 1x information desk
- 1x coat hanger
- 1x refrigerator, 1x system rack
- 1x wastebasket
- 2x spotlight with holder
- 1x fluorescent light
- 1x 220 V socket
- 1x socket for refrigerator
- 2x graphic surface 136 x 234 cm excl. graphics
- colour walls and fascia for an extra charge

R8
16 sqm

Standard stand - TYPE R8, 4 x 4 m, total price up to 31. 3. 2025 CZK 140 910,- excl. VAT after 31. 3. 2025 CZK 149 230,- excl. VAT

The price includes: 16 m2 exhibition area, registration fee, technical fee, stand construction incl. furnishings (see the list), carpet flooring, an inscription of up to 30 characters, power supply up to 3,6 kW incl. testing, daily cleaning, the company name and address in the fair catalogue and in the electronic information system, 2x Assembly/Dismantling Pass, 2x Exhibitor's Pass.

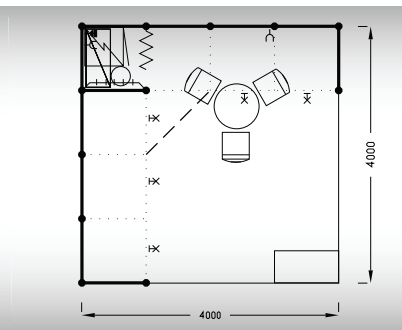

Stand furnishings:

- 1x 70 cm round table
- 3x chair Bystřice
- 1x information desk
- 1x coat hanger
- 1x refrigerator, 1x system rack
- 1x wastebasket
- 5x spotlights
- 2x 220 V socket
- 1x socket for refrigerator
- 1x graphic surface 136 x 67 cm
- 2x graphic wall 95 x 234 cm excl. graphics
- colour walls for an extra charge

R9
16 sqm

Standard stand - TYPE R9, 4 x 4 m, total price up to 31. 3. 2025 CZK 168 350,- excl. VAT after 31. 3. 2025 CZK 176 680,- excl. VAT

The price includes: 16 m2 exhibition area, registration fee, technical fee, stand construction incl. furnishings (see the list), carpet flooring, an inscription of up to 30 characters on fascia, power supply up to 6,9 kW incl. testing, daily cleaning, the company name and address in the fair catalogue and in the electronic information system, 2x Assembly/Dismantling Pass, 3x Exhibitor's Pass, input and waste of water.

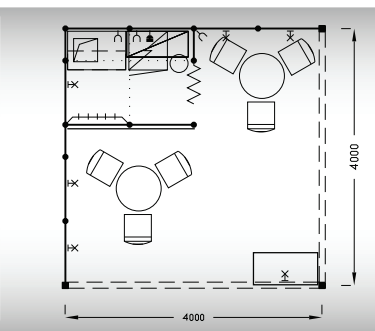

Stand furnishings:

- 2x 70 cm round table
- 6x chair Bystřice
- 1x information desk
- 1x kitchenette Omnia
- 1x coat hanger
- 1x refrigerator, 1x system rack
- 1x wastebasket
- 1x spotlight
- 5x spotlight with holder
- 3x 220 V socket
- 1x socket for refrigerator
- 1x graphic surface 200 x 250 cm excl. graphics
- colour walls and fascia for an extra charge

Common conditions for all types and sizes of stands:

- The stand will be ready at 10.00 a.m. one day before the fair begins
- Note! - stand dismantling will begin the following day after the fair has ended
- Structural changes for all types of packages are not possible
- Should the exhibitor attach their own posters /banners/ stickers to the wall panels inconsiderately resulting in panel damage, they will be charged an extra fee CZK 880,- / 1 piece
- Rejection or exchange of basic furnishings will not be compensated by any price reduction
- Changes in type and proportion of exhibition area for all types of package stands are not possible
- Stand cleaning is performed every morning before the fair begins

All inclusive stand packages - with one signature to the fair

BVV Trade Fairs Brno
 Výstaviště 405/1
 603 00 Brno
 Tel.: +420 601 252 613
 E-mail: lpokorna@bvv.cz
www.bvv.cz/expozice



October 7 - 10, 2025, Brno - Czech Republic, www.bvv.cz/msv

Special discount for registration till March 31, 2025

The standard stands can also be ordered in a ROW arrangement, see the online application form at www.bvv.cz/msv

R10
20 sqm

Standard stand - TYPE R10, 5 x 4 m, total price up to 31. 3. 2025 CZK 184 990,- excl. VAT after 31. 3. 2025 CZK 195 400,- excl. VAT

The price includes: 20 m2 exhibition area, registration fee, technical fee, stand construction incl. furnishings (see the list), carpet flooring, an inscription of up to 30 characters on fascia, power supply up to 6,9 kW incl. testing, daily cleaning, the company name and address in the fair catalogue and in the electronic information system, 2x Assembly/Dismantling Pass, 3x Exhibitor's Pass, input and waste of water.

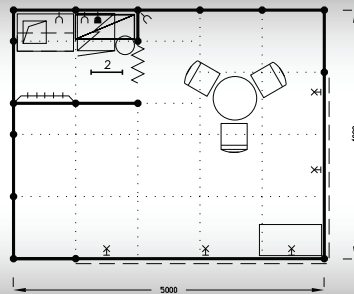

Stand furnishings:

- 1x 70 cm round table white
- 3x chair Bystřice
- 1x information desk
- 1x kitchenette Omnia
- 1x refrigerator, 1x system rack
- 1x coat hanger
- 1x wastebasket
- 5x spotlights
- 1x fluorescent light
- 3x 220 V socket
- 1x socket for refrigerator
- 2x graphic wall 95 x 234 cm
- 2x graphic surface 95 x 67 cm excl. graphics
- colour walls and fascia for an extra charge

R11
20 sqm

Standard stand - TYPE R11, 5 x 4 m, total price up to 31. 3. 2025 CZK 185 360,- excl. VAT after 31. 3. 2025 CZK 195 750,- excl. VAT

The price includes: 20 m2 exhibition area, registration fee, technical fee, stand construction incl. furnishings (see the list), carpet flooring, an inscription of up to 30 characters on fascia, power supply up to 6,9 kW incl. testing, daily cleaning, the company name and address in the fair catalogue and in the electronic information system, 2x Assembly/Dismantling Pass, 3x Exhibitor's Pass, input and waste of water.

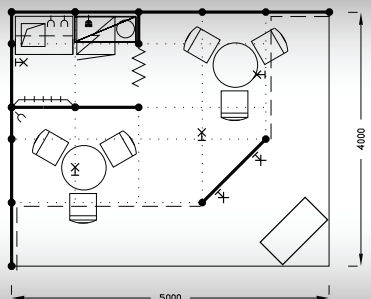
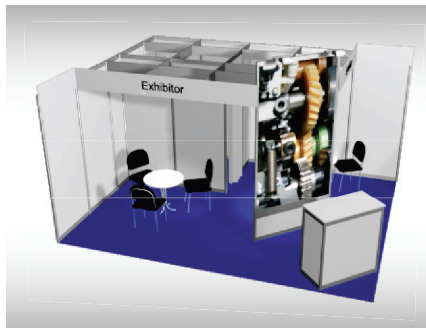

Stand furnishings:

- 2x 70 cm round table white
- 6x chair Bystřice
- 1x information desk
- 1x kitchenette Omnia
- 1x refrigerator, 1x system rack
- 1x coat hanger
- 1x wastebasket
- 4x spotlights
- 2x spotlight with holder
- 3x 220 V socket
- 1x socket for refrigerator
- 1x graphic wall 136 x 234 cm excl. graphics
- colour walls and fascia for an extra charge

R12
25 sqm

Standard stand - TYPE R12, 5 x 5 m, total price up to 31. 3. 2025 CZK 220 680,- excl. VAT after 31. 3. 2025 CZK 233 670,- excl. VAT

The price includes: 25 m2 exhibition area, registration fee, technical fee, stand construction incl. furnishings (see the list), carpet flooring, an inscription of up to 30 characters on fascia, power supply up to 6,9 kW incl. testing, daily cleaning, the company name and address in the fair catalogue and in the electronic information system, 2x Assembly/Dismantling Pass, 3x Exhibitor's Pass, input and waste of water, 1x unspecified car entry.

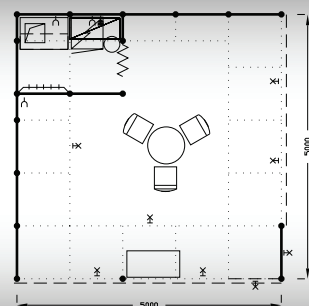

Stand furnishings:

- 1x 70 cm round table white
- 3x chair Bystřice
- 1x information desk
- 1x kitchenette Omnia
- 1x refrigerator, 1x system rack
- 1x wastebasket
- 6x spotlights
- 2x spotlight with holder
- 3x 220 V socket
- 1x socket for refrigerator
- 1x graphic wall 95 x 234 cm
- 2x graphic surface 95 x 67 cm excl. graphics
- colour walls and fascia for an extra charge

Common conditions for all types and sizes of stands:

- The stand will be ready at 10.00 a.m. one day before the fair begins
- Note! - stand dismantling will begin the following day after the fair has ended
- Structural changes for all types of packages are not possible
- Should the exhibitor attach their own posters /banners/ stickers to the wall panels inconsiderately resulting in panel damage, they will be charged an extra fee CZK 880,- / 1 piece
- Rejection or exchange of basic furnishings will not be compensated by any price reduction
- Changes in type and proportion of exhibition area for all types of package stands are not possible
- Stand cleaning is performed every morning before the fair begins

All inclusive stand packages - with one signature to the fair

BVV Trade Fairs Brno
 Výstaviště 405/1
 603 00 Brno
 Tel.: +420 601 252 613
 E-mail: lpokorna@bvv.cz
 www.bvv.cz/expozice



October 7 - 10, 2025, Brno - Czech Republic, www.bvv.cz/msv

Special discount for registration till March 31, 2025

VP 1
9 sqm

Standard stand - TYPE VP1, 3 x 3 m, total price up to 31. 3. 2025 CZK 70 380,- excl. VAT after 31. 3. 2025 CZK 72 170,- excl. VAT

The price includes: 9 m2 exhibition area, registration fee, technical fee, stand construction incl. furnishings (see the list), carpet flooring, an inscription of up to 30 characters on fascia, power supply up to 6,9 kW incl. testing, daily cleaning, the company name and address in the fair catalogue and in the electronic information system, 2x Assembly/Dismantling Pass, 2x Exhibitor's Pass.



Stand furnishings:

- 1x 70 cm round table
- 3x chair Bystřice
- 1x lockable cabinet
- 1x refrigerator
- 1x coat rack
- 1x wastebasket PVC
- 1x 220 V socket
- 1x socket for refrigerator
- colour walls and fascia for an extra charge

VP 2
18 sqm

Standard stand - TYPE VP2, 6 x 3 m, total price up to 31. 3. 2025 CZK 98 920,- excl. VAT after 31. 3. 2025 CZK 102 510,- excl. VAT

The price includes: 18 m2 exhibition area, registration fee, technical fee, stand construction incl. furnishings (see the list), carpet flooring, an inscription of up to 30 characters on fascia, power supply up to 6,9 kW incl. testing, daily cleaning, the company name and address in the fair catalogue and in the electronic information system, 2x Assembly/Dismantling Pass, 2x Exhibitor's Pass.

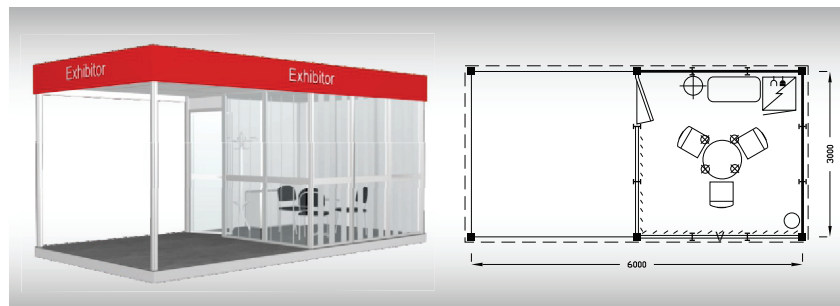

Stand furnishings:

- 1x 70 cm round table
- 3x chair Bystřice
- 1x lockable cabinet
- 1x refrigerator
- 1x coat rack
- 1x wastebasket PVC
- 1x 220 V socket
- 1x socket for refrigerator
- colour walls and fascia for an extra charge

VP 3
18 sqm

Standard stand - TYPE VP3, 6 x 3 m, total price up to 31. 3. 2025 CZK 116 320,- excl. VAT after 31. 3. 2025 CZK 119 910,- excl. VAT

The price includes: 18 m2 exhibition area, registration fee, technical fee, stand construction incl. furnishings (see the list), carpet flooring, an inscription of up to 30 characters on fascia, power supply up to 6,9 kW incl. testing, daily cleaning, the company name and address in the fair catalogue and in the electronic information system, 2x Assembly/Dismantling Pass, 2x Exhibitor's Pass, input and waste of water.

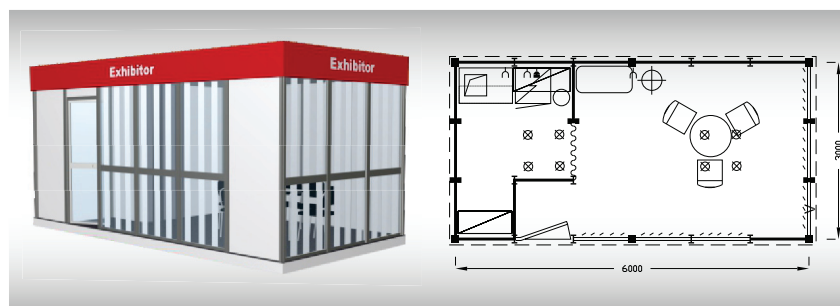

Stand furnishings:

- 1x 70 cm round table
- 3x chair Bystřice
- 1x lockable cabinet
- 1x kitchenette Omnia
- 1x refrigerator, 2x system rack
- 1x coat rack
- 1x wastebasket PVC
- 3x 220 V socket
- 1x socket for refrigerator
- colour walls and fascia for an extra charge

Common conditions for all types and sizes of stands:

- The stand will be ready at 10.00 a.m. one day before the fair begins
- Note! - stand dismantling will begin the following day after the fair has ended
- Structural changes for all types of packages are not possible
- Should the exhibitor attach their own posters /banners/ stickers to the wall panels inconsiderately resulting in panel damage, they will be charged an extra fee CZK 880,- / 1 piece
- Rejection or exchange of basic furnishings will not be compensated by any price reduction
- Changes in type and proportion of exhibition area for all types of package stands are not possible
- Stand cleaning is performed every morning before the fair begins

All inclusive stand packages - with one signature to the fair

DIGITAL FACTORY 2.0

BVV Trade Fairs Brno
 Výstaviště 405/1
 603 00 Brno
 Tel.: +420 601 252 613
 E-mail: lpokorna@bvz.cz
www.bvz.cz/expozice



**DIGITAL
FACTORY**



October 7 - 10, 2025, Brno - Czech Republic, www.bvz.cz/msv

Packages exclusively for the DIGITAL FACTORY 2.0 project

Exhibitor package - Type DIGI 01, 2 x 2 m, total price CZK 53 090,- excl. VAT

Price includes:

- exhibition area 4 sqm
- **Meeting point** (seating area - bar table, 2 bar stools, banner 1 x 2,5 m - illuminated Octalumina, socket, 4 sqm carpet - unified colour, without change, daily cleaning)
- **PR support**
- **presentation at DigiStage**
- registration fee, technical fee
- presentation of basic data in the trade fair catalogue and in the electronic information system
- 2 Assembly / Dismantling Passes,
2 Exhibitor Passes

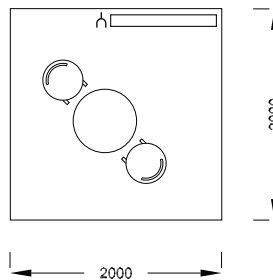

Exhibitor package - Type DIGI 02, 3 x 3 m, total price CZK 85 890,- excl. VAT

Price includes:

- exhibition area 9 sqm
- **Meeting point** (seating area - 1x table, 3 chairs, banner 1 x 2,5 m - illuminated Octalumina, socket, 9 sqm carpet - unified colour, without change, daily cleaning)
- **PR support**
- **presentation at DigiStage**
- registration fee, technical fee
- presentation of basic data in the trade fair catalogue and in the electronic information system
- 2 Assembly / Dismantling Passes,
2 Exhibitor Passes

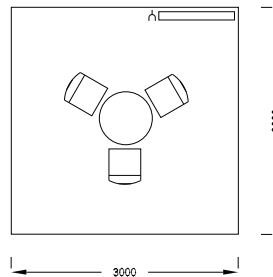

Exhibitor package - Type DIGI 03, 5 x 4 m, total price CZK 167 480,- excl. VAT

Price includes:

- exhibition area 20 sqm
- **Meeting point** (seating area - 2 conference tables, 6 chairs), banner 1 x 2,5 m - illuminated Octalumina, back area 2 x 1,5 m (shelving unit, refrigerator, hange rail, waste bin, 24h socket, socket, lighting), 20 sqm carpet - unified colour, without change, daily cleaning, 2x space for graphic design 1 x 2,5 m (on the wall back area)
- **PR support**
- **presentation at DigiStage**
- registration fee, technical fee
- presentation of basic data in the trade fair catalogue and in the electronic information system
- 2 Assembly / Dismantling Passes,
2 Exhibitor Passes

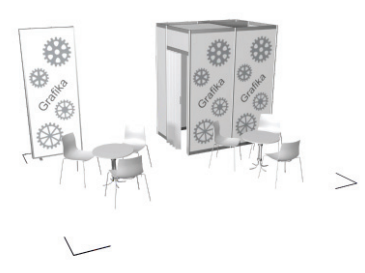
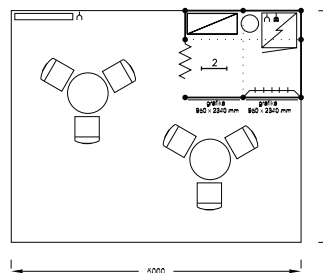

Common conditions for all types and sizes of stands:

- The stand will be ready at 10.00 a.m. one day before the fair begins
- **Note!** - stand dismantling will begin the following day after the fair has ended
- Structural changes for all types of packages are not possible
- Should the exhibitor attach their own posters /banners/ stickers to the wall panels inconsiderately resulting in panel damage, they will be charged an extra fee CZK 880,- / 1 piece
- Rejection or exchange of basic furnishings will not be compensated by any price reduction
- Changes in type and proportion of exhibition area for all types of package stands are not possible
- Stand cleaning is performed every morning before the fair begins

All inclusive stand packages - with one signature to the fair



BVV Trade Fairs Brno
 Výstaviště 405/1
 603 00 Brno
 Tel.: +420 601 252 613
 E-mail: lpokorna@bvv.cz
www.bvv.cz/expozice









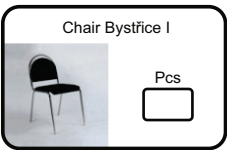
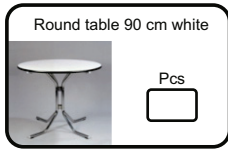
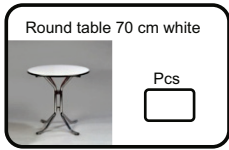

October 7 - 10, 2025, Brno - Czech Republic, www.bvv.cz/msv

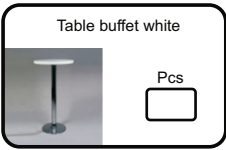
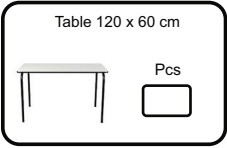
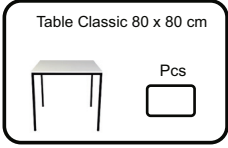
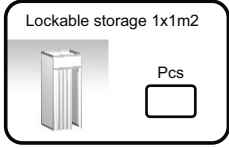
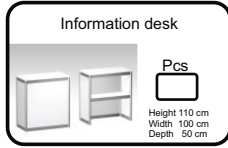
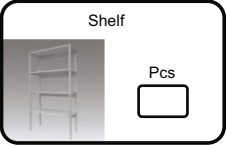
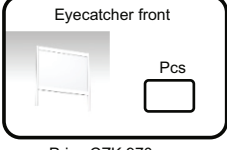
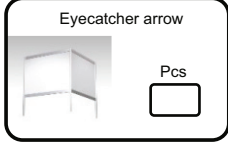
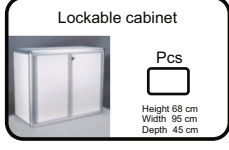
ADDITIONAL STAND EQUIPMENT

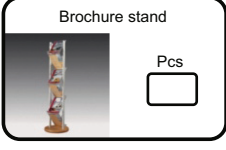
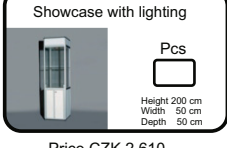
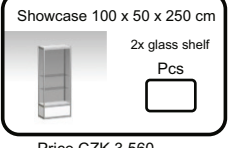
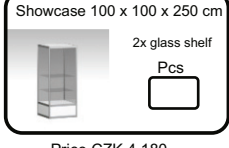
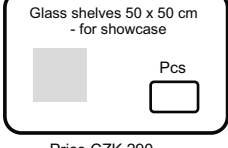
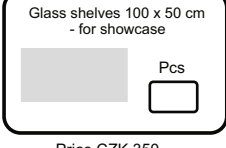
Exhibitor / Company name:		
Company address:		Place of business:
Contact person:		
Phone:	Fax:	E-mail:

We make a firm order for additional equipment in addition to _____ package (please indicate the type and size).

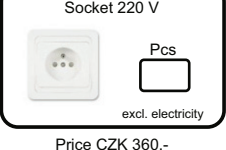
 <p>Chair Bystřice I</p> <p>Pcs <input type="text"/></p> <p>Price CZK 350,-</p>	 <p>Round table 90 cm white</p> <p>Pcs <input type="text"/></p> <p>Price CZK 710,-</p>	 <p>Round table 70 cm white</p> <p>Pcs <input type="text"/></p> <p>Price CZK 580,-</p>	 <p>Bar stools „Z”</p> <p>Pcs <input type="text"/></p> <p>Price CZK 900,-</p>	 <p>Table buffet white</p> <p>Pcs <input type="text"/></p> <p>Price CZK 1 170,-</p>
 <p>Table 120 x 60 cm</p> <p>Pcs <input type="text"/></p> <p>Price CZK 590,-</p>	 <p>Table Classic 80 x 80 cm</p> <p>Pcs <input type="text"/></p> <p>Price CZK 410,-</p>	 <p>Lockable storage 1x1m2</p> <p>Pcs <input type="text"/></p> <p>Price CZK 2 650,-</p>	 <p>Information desk</p> <p>Pcs <input type="text"/></p> <p>Height 110 cm Width 100 cm Depth 50 cm</p> <p>Price CZK 1 950,-</p>	 <p>Shelf</p> <p>Pcs <input type="text"/></p> <p>Price CZK 900,-</p>
 <p>Eyecatcher front</p> <p>Pcs <input type="text"/></p> <p>Price CZK 970,-</p>	 <p>Eyecatcher arrow</p> <p>Pcs <input type="text"/></p> <p>Price CZK 1 580,-</p>	 <p>Lockable cabinet</p> <p>Pcs <input type="text"/></p> <p>Height 68 cm Width 95 cm Depth 45 cm</p> <p>Price CZK 1 350,-</p>	 <p>Table showcase</p> <p>Pcs <input type="text"/></p> <p>Height 98 cm Width 95 cm Depth 45 cm</p> <p>Price CZK 2 340,-</p>	 <p>Brochure stand</p> <p>Pcs <input type="text"/></p> <p>Price CZK 1 080,-</p>
 <p>Showcase with lighting</p> <p>Pcs <input type="text"/></p> <p>Height 200 cm Width 50 cm Depth 50 cm</p> <p>Price CZK 2 610,-</p>	 <p>Showcase 100 x 50 x 250 cm</p> <p>2x glass shelf</p> <p>Pcs <input type="text"/></p> <p>Price CZK 3 560,-</p>	 <p>Showcase 100 x 100 x 250 cm</p> <p>2x glass shelf</p> <p>Pcs <input type="text"/></p> <p>Price CZK 4 180,-</p>	 <p>Glass shelves 50 x 50 cm - for showcase</p> <p>Pcs <input type="text"/></p> <p>Price CZK 290,-</p>	 <p>Glass shelves 100 x 50 cm - for showcase</p> <p>Pcs <input type="text"/></p> <p>Price CZK 350,-</p>
 <p>Kitchenette Omnia</p> <p>Pcs <input type="text"/></p> <p>excl. input and waste of water</p> <p>Price CZK 4 000,-</p>	 <p>Refrigerator incl. socket</p> <p>Pcs <input type="text"/></p> <p>Price CZK 3 320,-</p>	 <p>Spotlight</p> <p>Pcs <input type="text"/></p> <p>Price CZK 450,-</p>	 <p>Spotlight with holder</p> <p>Pcs <input type="text"/></p> <p>Price CZK 960,-</p>	 <p>Socket 220 V</p> <p>Pcs <input type="text"/></p> <p>excl. electricity</p> <p>Price CZK 360,-</p>

Other facilities can be ordered on a supplementary basis - see ieso.bvv.cz

Place, date

Name and surname of person authorised to sign on behalf of the exhibitor, stamp and signature